

# N<sub>2</sub>BLAST<sup>®</sup>

## FPS-900-RS Fire Protection Systems O&M Manual

Version 4; 7/2021

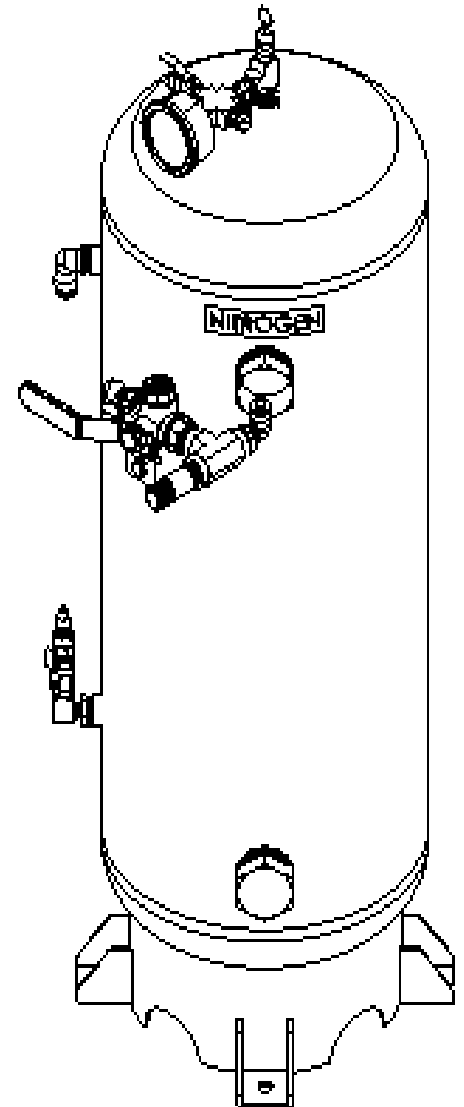
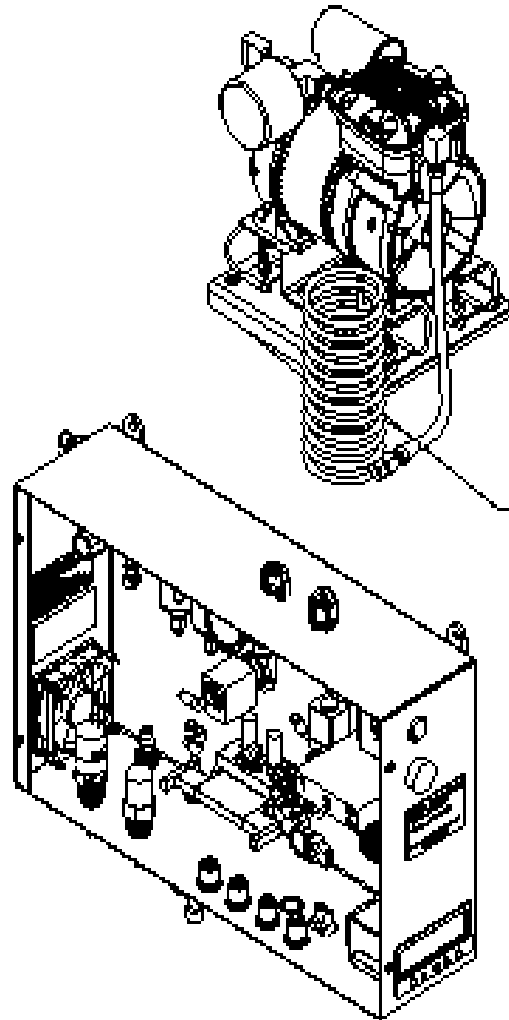
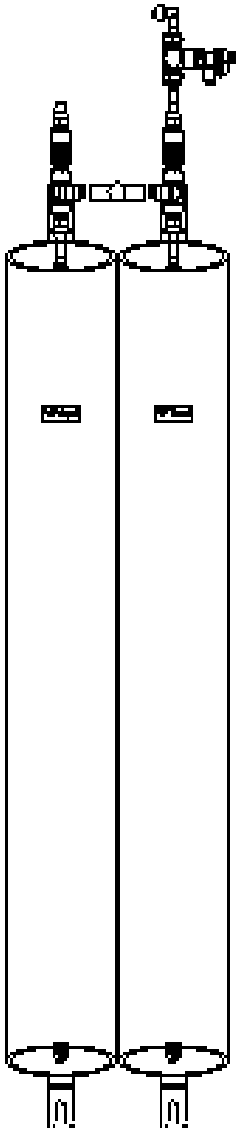

**TABLE OF CONTENTS:**

1. INTRODUCTION..... 3

    1.1. General Purpose

    1.2. Audience

    1.3. Important Information

    1.4. Limits of Liability

    1.5. Service Return Policy

2. SAFETY GUIDELINES..... 5

    2.1. General

3. RECEIVING, UNPACKING, AND STORAGE INSTRUCTIONS..... 7

    3.1. Unpacking and Preparation

4. SITE AND UTILITY REQUIREMENTS..... 8

    4.1. Air Supply

    4.2. Additional Piping's and Hosing's

    4.3. Electrical Requirements

    4.4. Site Specifications

5. PRODUCT INSTALLATION..... 9

    5.1. Installation Arrangement

6. SYSTEM DESIGN ..... 11

    6.1. Key Features

    6.2. Specifications

7. SYSTEM OPERATION ..... 13

    7.1. General

    7.2. Controller Modes

    7.3. Normal Run / Standby Mode

    7.4. Stopping the System

    7.5. Alarm Mode

    7.6. Communication (Modbus RTU)

8. START-UP PROCEDURES ..... 18

    8.1. Start-Up Procedures

    8.2. Checking for Leaks

9. SYSTEM MAINTENANCE ..... 21

    9.1. Air Intake Filter

    9.2. Air Filter Replacement

10. KEY CONTACTS ..... 23

11. FAQs ..... 24

    11.1. Power Issues

    11.2. Pressure Issues

    11.3. Gas Leaks

APPENDIX A: Advanced Options ..... 25

APPENDIX B: WARRANTY ..... 28

## 1. Introduction

### 1.1. General Purpose

This manual provides proper installation and use of South-Tek Systems *N<sub>2</sub>-BLAST<sup>®</sup>* FPS-900-RS. South-Tek Systems is not responsible for damages when using this in manners not approved by South-Tek Systems. The user(s) of this document should confer any questions with a qualified South-Tek Systems representative on its commissioning and correct use.

Please contact South-Tek Systems with any question or concerns at:

South-Tek Systems, LLC  
3700 U.S. Highway 421 North  
Wilmington, NC, 28401  
Tel: (888) 526-6284  
Email: [Info@southteksystems.com](mailto:Info@southteksystems.com)  
<http://www.southteksystems.com/>

This document is based upon the R&D performed by the South-Tek Systems Engineering Team.

**WARNING: Read the manual in its entirety before installing or using the equipment.**

### 1.2. Audience

This manual is for Installer/Supervisory Staff. Read the entire manual before operating. Please contact the local provider for any operation and maintenance questions before contacting the manufacturer.

### 1.3. Important Information

All personnel (and their supervisors) installing, operating, and maintaining the *N<sub>2</sub>-BLAST<sup>®</sup>* must read and fully understand this manual prior to installing, operating or performing maintenance.

The *N<sub>2</sub>-BLAST<sup>®</sup>* produces nitrogen (N<sub>2</sub>) at a low flow rate, which quickly dissipates into the air. N<sub>2</sub> gas is not poisonous, but do not directly inhale, since high concentrations can cause asphyxiation. Install the unit in a well-ventilated room that is not sealed off from normal living space air changes.

All personnel involved with the installation, operations, and maintenance of the *N<sub>2</sub>-BLAST<sup>®</sup>* must follow safe working practices, including OSHA and local health/safety code regulations.

### 1.4. Limits of Liability

Buyer's exclusive remedy for all claims shall be for damages, and seller's total liability for any and all losses and damages arising out of any cause whatsoever including, without limitation, defects in or defective performance of the system, (whether such claim be based on contract, negligence, strictly liability, other tort or otherwise) shall in no event exceed the purchase price of the system in respect of which such cause arises or, at seller's option, the repair or replacement of such; and in no event shall seller be liable for incidental, consequential or punitive damages resulting from any such cause.

Seller shall not be liable for, and Buyer assumes all liability for, the suitability and the results of using nitrogen by itself or in any manufacturing or other industrial process or procedure, all personal injury and property damages connected with the possession, operation, maintenance, other use or resale of the System. Transportation charges for the return of the System shall not be paid unless authorized in advance by Seller.

---

*NOTE: Any MODIFICATIONS made by the customer, without the written consent of South-Tek Systems, will void the product's warranty.*

---

### **1.5. Service Return Policy**

Follow these procedures to return the system when performing site repairs is not possible:

- The owner must get a Return Material Authorization number, which references the model and serial, from South-Tek Systems. South-Tek Systems will not accept any items for service or credit without written authorization from South-Tek Systems.
- Return all items within the original packaging material if possible. Package all items for safe return to South-Tek Systems. South-Tek Systems will not be responsible for damages, which occur in transit. Damages occurred from failing to adhere to these procedures will be the customer's responsibility. Contact South-Tek Systems for a return shipping address.
- Shipping charges must be prepaid on all returns.

## 2. Safety Guidelines

The following section outlines the basic safety considerations about installation and operation of the *N<sub>2</sub>-BLAST®* FPS-900-RS.

### 2.1. General

Using the *N<sub>2</sub>-BLAST®* FPS-900-RS correctly is important for safety and trouble-free operation. Wrong use can cause damages to the system or can lead to incorrect gas supply.

Read carefully and act accordingly before installing, operating, or repairing the unit:

- The operator must use safe working practices and rules when running the nitrogen generator.
- The owner is responsible for always keeping the unit in safe working conditions.
- Always use approved parts when performing maintenance and repairs. Make sure that replacement parts meet or exceed the original parts' specifications.
- Only competent individuals, trained and authorized, can install, operate, or perform maintenance and repairs.
- Isolate incoming and outgoing pressures to the generator, and depressurize the service or repair section before performing any mechanical work, including changing the filters. Vent the nitrogen generator's exhaust gas outside or to a large, well-ventilated room to avoid suffocation due to lack of oxygen.
- Wear safety glasses if the cabinet door is open while the machine is running.
- Use ear protection when the equipment is running.

**WARNING: Components may experience pressure during operation. Pressurized gases are dangerous and may cause injury or death if handled or used inappropriately.**

- **Never allow pressurized gas to exhaust from an unsecured hose. An unsecured hose may present a whipping action, which can cause serious injury. If a hose burst during use, immediately close all isolation valves if safe and turn off the unit.**
- **Never disable or bypass any safety relief valves.**
- **Always disconnect the supply power to the nitrogen generator prior to performing electrical work.**

---

*NOTE: Always follow local and site safety regulations in conjunction with this manual. Correct use of the nitrogen generator is important for personal safety. Incorrect safety practices can cause damage to the individual and equipment.*

---

Follow safe working practices, OSHA, and local health and safety regulation when installing and maintaining the *N<sub>2</sub>-BLAST®* FPS-900-RS.

**WARNING: Read the manual before installing and operating the nitrogen generator to prevent accidents and damages.**

- **Contact the supplier for questions not answered in this manual.**

- **Only use the FPS-900-RS for its designed purpose.**
- **Only qualified service-engineers may work on installation, maintenance and repairs.**
- **Unqualified people should not work on the equipment.**
- **Do not tamper or experiment with the equipment or exceed the technical specifications.**

### 3. Receiving, Unpacking, and Storage Instructions

#### 3.1. Unpacking and Preparation

The *N<sub>2</sub>-BLAST*<sup>®</sup> FPS-900-RS will arrive in a cardboard box. Open the box carefully, and identify and verify all parts listed on the packing list are present and undamaged. South-Tek Systems (STS) is not responsible for damages that occur during shipping and handling of the *N<sub>2</sub>-BLAST*<sup>®</sup>. Document any visual damages and report them to the responsible shipping company, and then, contact STS at (888) 526-6284 to assess the damages.

#### Until Installation:

- Store the *N<sub>2</sub>-BLAST*<sup>®</sup> in a dry and climate controlled (40-100° F) room.
- Always keep *N<sub>2</sub>-BLAST*<sup>®</sup> in an upright position / or, preferably, in the box as shipped.
- Read entire manual and make all connections (per instructions) before connecting power.
- Keep all gas lines dry so moisture does not enter generator upon hookup.
- Never place/stack objects on top of the *N<sub>2</sub>-BLAST*<sup>®</sup>.

Remove the nitrogen generator from the cardboard box by carefully lifting the unit out and setting it on a flat surface. Prepare the wall mounting bracket before moving it to the final location. Carefully, break down the cardboard box and store in a safe location. Reuse the cardboard box if returning for factory service.

## 4. Site and Utility Requirements

### 4.1. Air Supply

The *N<sub>2</sub>-BLAST®* FPS-900-RS includes a built-in air compressor to supply gas to the nitrogen generator. It is not for performing quick fills. Please install a separate suitable air compressor for other needs.

### 4.2. Additional Piping and Hosing

Sourcing and installing additional plumbing, supplied by other manufacturers, must meet all of the unit's flow, pressure, and temperature requirements. If piping length between any equipment is greater than 50 feet, consult with a piping contractor for proper line size.

### 4.3. Electrical Requirements

The *N<sub>2</sub>-BLAST®* FPS-900-RS requires 120VAC / 50-60hz / Single Phase (1Φ). A 240VAC option is also available. It has a built-in 10Amp fuse and comes with hard wire to terminal blocks for customer connection. It comes with UL 508A ICP certification and the electrical schematics are available upon request.

### 4.4. Site Specifications

Unless designed otherwise, install in a nonhazardous indoor location with temperatures between 40-100°F (4°- 38°C).



## 5. Product Installation

### 5.1. INSTALLATION ARRANGEMENT

See below for basic setup. Refer to the General Arrangement drawing for detailed instructions included with the installation package:

#### **GA-FPS-00900-RELIABLE**

#### **Product Assembly Instructions:**

All *N<sub>2</sub>-BLAST*<sup>®</sup> FPS-900-RS mounting holes and wall mounting bracket holes are for 1/4" screws/anchors (not provided).

1. Review drawing set for general arrangement provided within the system enclosure.
2. Install sieve beds:
  - a) The sieve beds are part of the sub-assembly, FPS-00900-Reliable-03, but will be shipped separately
  - b) Sieve beds will come pre-assembled with mounting brackets for placing into the **Reliable**<sup>®</sup> cabinet. Brackets are designed for Qty. Six 1/4"-20 bolts, not included. See General Arrangement for location of holes.
  - c) They should be placed in the cabinet one sieve bed at a time. They are marked "**bed A**" and "**bed B**." Bed A should be on the left facing the cabinet.
  - d) The lower bracket is slotted so that the sieve bed may be set down on top of the fastener for ease of installation.
  - e) Once the bed is set on the lower fastener, the top bracket should be secured in place using both mounting holes in the bracket.
  - f) Once the upper brackets are secured firmly in place, secure the lower bracket with a nut, wing nut, or similar fastener.
3. Assemble nitrogen output fittings on sieve beds:
  - a) The nitrogen output fittings are part of FPS-00900-Reliable-03 sieve bed assembly, but are shipped loose as a sub-assembly.
  - b) Locate the sub-assembly to place on top of the sieve bed assembly.
  - c) The sub-assembly terminates in two metal stem push to connect fittings on each side.
  - d) The sub-assembly should be firmly placed into the top of the sieve bed which has female push to connect fittings to receive the stems. The stems should "snap" into place and hold securely.
  - e) Test that the fittings are secure before moving forward.
4. Install nitrogen storage tank:
  - a) The nitrogen storage tank, FPS-00900-Reliable-04, will come pre-assembled with all necessary fittings.
  - b) The tank will need to be placed in the Reliable cabinet and secured in place with four (4) fasteners, not included.

- c) Ensure that it is oriented so that the “Nitrogen” label and pressure gauge face the front of the cabinet.
5. Install air compressor and bracket to back side of cabinet enclosure.
    - a) The air compressor assembly will be shipped and installed on the air compressor bracket.
    - b) The bracket needs to be bolted in place into the proper location at the back of the cabinet.
    - c) It is designed to use Qty. Four (4) 1/4”-20 bolts.
    - d) For mounting pattern see General Arrangement drawing supplied with system.
  6. Install the *N<sub>2</sub>-BLAST*<sup>®</sup> electrical enclosure into the Reliable cabinet:
    - a) The electrical enclosure, FPS-00900-Reliable-01, will be shipped fully assembled.
    - b) The cabinet is designed for Qty. Four (4) 1/4”-20 hardware.
    - c) For the location and mounting pattern see the General Arrangement drawing.
    - d) Ensure that the PLC, gauge and switches all face the front of the cabinet.
  7. Install bypass handle to the air maintenance device:
    - a) Bypass handle, part of FPS-00900-Reliable-04, will come pre-assembled.
    - b) It will need to be connected to the AMD by threading a nipple into both parts.
    - c) The threads are 1/2” NPTF. Ensure that they are taped sufficiently to seal.
  8. Plumb all fittings as specified in product general arrangement drawing (Refer to applicable labels and General Arrangement drawing for connections.)
    - a) Qty: 7 - 1/4” PTC OD tube fitting from valve cabinet
    - b) Qty: 5 – 1/4” PTC OD tube fitting from sieve bed assembly
    - c) Qty: 1 – 1/4” PTC OD tube fitting from compressor assembly
    - d) Qty: 2 – 1/4” PTC OD tube fitting from nitrogen tank
    - e) Qty: 1 – 1/2” PTC OD tube fitting from nitrogen tank
    - f) Qty: 1 – 1/2” PTC OD tube fitting from air bypass valve
    - g) Qty: 1 – 1/2” NPT male fitting to AMD (AMD provided by others)
    - h) Qty: 1 – 1/2” NPT female fitting to air bypass compressor outlet
    - i) Qty: 1 – 1/4” PTC OD tube fitting from bypass handle assembly to valve cabinet
  9. Apply external electrical connections to the unit and bypass handle sensor via quick connector plugs and wire leads, as shown on the General Arrangement drawing.
    - a) Connect and wire compressor electrical using supplied quick disconnect.
    - b) Connect and wire main power using supplied 16’ power cable with flying leads.
    - c) Connect and wire alarm connection customer contact, alarm process using supplied 16’ of wire.
    - d) Connect and wire magnetic switch to bypass handle assembly using supplied quick disconnect.

## 6. System Design

### 6.1. Key Features

The *N<sub>2</sub>-BLAST®* FPS-900-RS key features include the following:

- Air Compressor
- Safety Relief Valves
- Programmable Logic Controller (PLC)
- N<sub>2</sub> Tank
- Air Filters
- Pressure Swing Adsorption Beds
- Automatic Pressure Cut-in/Cut-out
- Patented BlastOff® Leak Detection System

#### 6.1.1. Air Compressor

An oil-less internal air compressor has an engineered dampening system reducing vibration and noise throughout the cabinet. The air compressor has a pre-filter to catch small particulates that can cause damage. The recommended replacement for the pre-filter is 1000 run hours or 1-year, whichever comes first. Dirtier environments may need more frequent changes. Consult with the supplier for a different filter maintenance schedule if installing in a dirty environment.

#### 6.1.2. Air Filters

The generator has an air inlet pre-filters and two filters between the compressed air and O<sub>2</sub> separation beds - the particulate and coalescing. The 5-micron particulate filter catches the bulk particles, and the 0.1 micron coalescing catches the remaining smaller particles. Both filters feature an auto-drain that drains any water buildup within the filter housing. These drain lines are on the cabinet's bottom right side. Connect these drain lines to a safe location.

#### 6.1.3. Programmable Logic Controller (PLC)

An integrated PLC on the cabinet features smart timing to maximize the generator's performance. It controls the valve timing and sequencing to move compressed gas throughout the system. It also has a smart feature to automatically switch between different "modes" based on the current run stages (see Chapter 7: System Operation for more about the unit's functionality).

#### 6.1.4. Safety Relief Valves (SRVs)

The installed ASME safety relief valves add additional safety to protect component failures.

#### 6.1.5. Nitrogen Tank

The nitrogen tank comes with ball valves, safety relief, and a gauge. The outlet gas connects to an external manual ball valve for easy plug and play connection.

### 6.1.6. Automatic Cut-In and Cut-Out

The generator starts and stops based on a pressure switch. Do not adjust the factory preset cut-in and out pressure without first consulting with South-Tek Systems.

### 6.1.7. Patented BlastOff® – Leak Detection System

The BlastOff® Leak Detection System is a patented feature which sends an alarm if it detects a possible gas leak. The alarm signal can be an audible, visual, and Fire Alarm Control Panel. Power cycle the unit to reset the alarm, but avoid doing this multiple times, without finding the cause, as it will shorten the generator's life.

## 6.2. Specifications

N2-Blast FPS-900-RS	
Nitrogen Purity	98.5+%
Installation	Internally Integrated (PrePak)
Display	Hours / Run / Standby Alarms
N <sub>2</sub> Storage Pressure	60-70 PSIG (+/-5%)
Cabinet Port Connections	1/2" NPT Female
Electrical	110-220V / 50-60 Hz / 1 Phase; 10 Amp Fuse
Compressor	Integral / Oil-Free
Ambient Temperature	40° to 100°F
Noise Level (dba)	< 90 dbA
Size	5"W x 19"D x 12"H (Cabinet Dimensions)

## 7. System Operation

### 7.1. General

The nitrogen generator uses valve sequencing to produce nitrogen. The design meets specifications of a fire protection system. Consult with South-Tek System for written approval before performing any field changes or customization. Unauthorized changes void all warranties and may cause damages or malfunctions to the system.

This section describes the major control functions and instrumentations associated with the nitrogen generators. All programs are proprietary and password protected from the factory. Do not alter any controls or instrumentations. Changes without South-Tek Systems' written consent voids the performance specifications.



**Figure 1: Controller Display**

---

*Note: Install the nitrogen generator per “Section 5: Product Installation” and perform the startup procedures in “Section 8: Startup Procedures” before performing normal operations.*

---

## 7.2. Controller Modes

This mode allows access to several features:

- Filter Change Reset - When a new FRP (Filter Replacement Kit) is installed, the 1000-hour filter change time must be reset. After replacing the filter elements, press and hold the Filter Change Reset Button (Down Button) for 7 seconds. An audible beep will confirm that the time is reset and filter alarm will be reset.
- Blastoff® Simulation - Hold the (Set Button) for 7 seconds Passcode Screen will pop up,
  1. Press the (Set Button) one time to activate data entry, Enter (6557) using the (Up and Down Buttons)
  2. Press the (ENT Button) to confirm the entry.

It will bring (HOLD SET) Screen, to simulate the Blastoff, press and hold the Set Button for 5 seconds this will simulate the Blastoff and trip the alarm dry contact in the unit (if installed) for 2 seconds so that proper functioning can be confirmed.



- Next Button - to navigate between the screens as filter hours, program version, unit ambient temperature, and the sensors screens if it's applicable (check appendix A).

## 7.3. NORMAL RUNNING / STANDBY MODE (RUNNING -STANDBY)

“Running” mode is when the FPS-900-RS is producing nitrogen and supplying it to the storage tank. The system will automatically enter “Standby” mode when the tank is fully pressurized (70 PSIG +/-5 PSIG). It will remain in “Standby” mode until the tank pressure falls 7-10 PSIG.

**To run the system in normal run mode:**

1. Connect the correct power supply to the system.
2. Open the nitrogen generator’s 3-way outlet ball valve (lower left side of the cabinet) to nitrogen out position.
3. On the nitrogen tank, open the gas inlet and outlet ball valve.
4. Push the On/Off toggle button on the upper left control panel to the “On” position (up) and the system will automatically turn on and start filling nitrogen to the storage tank.

## 7.4. Stopping the System

### To stop the system:

1. Close off the gas outlet valve on the nitrogen storage tank.
2. System will automatically stop once it reaches the cut-out pressure of approximately 65-75 PSIG.
3. In the case of an emergency shut off, push the On/Off toggle button on the upper left control panel to the “Off” position. The unit will shut down immediately.

## 7.5. Alarm Mode

when an alarm mode is activated, it will trigger the audible buzzer, alarm contact, and flash the cause of the alarm on the screen. The customer alarm contact wiring can be viewed on the supplied wiring diagram. The customer alarm dry contact is constantly energized and will constantly illuminate the LED indicator on top of the contact. This is so when there is no power, or power is lost on the system, the contact will de-energize and show a fault condition. The alarm contact has a max rating of 6A at 250VAC and 2A at 24VDC.

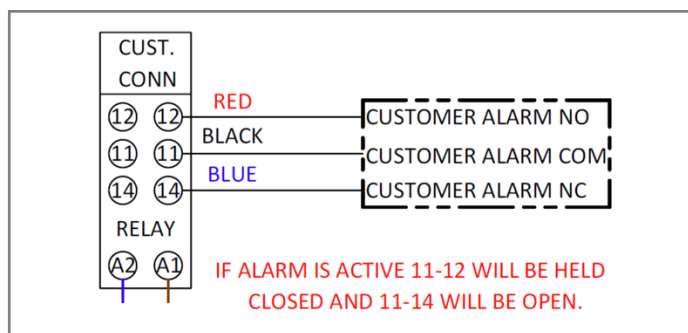

**Figure 2: FPS-900-RS Alarm Contact Diagram**

### 7.5.1. Bypass Mode (Air n2 bypass)

during the 30-minute fire protection system fill test or when a potential issue with the generator is detected, the operator can switch the system into manual bypass mode by turning the handle on the 3-way ball valve to the bypass position. With the handle in the “Bypass Mode”, the bypass alarm triggers the audible buzzer, alarm contact, and flashes “Air n2 bypass” on the controller’s 7-segment display. The alarm will turn off once the handle is back to normal run position.

### 7.5.2. BlastOff® Alarm Mode (BLAsstoff 9H.run)

The nitrogen generator activates a BlastOff® Alarm when it detects potential leaks or nitrogen being overdrawn. The BlastOff® Alarm will trigger the audible buzzer, alarm contact, and flash “BLAsstoff 9H.Run” on the controller’s 7-segment display. Inspect and test the system

for leaks and component failures. Power cycle the unit to reset the alarm but avoid doing this without finding the cause, as it will shorten the generator's life. Contact South-Tek Systems, or the local installer, for further troubleshooting.

### 7.5.3. Low System Pressure Alarm Mode

The Low System Pressure alarm activates when a system pressure is detected below the normal functioning limits of the nitrogen generator. This may be from an issue with the generator, a supply valve being shut off, or caused by a large leak in the fire protection system. The Low Pressure Alarm will trigger the audible buzzer, alarm contact, and flash "**N2 PRESS ALAR.**" on the controller's 7-segment display.

### 7.5.4. Power Loss Alarm Mode (-----)

The Power Loss Alarm activates when the nitrogen generator loses power for any reason. This will cause the alarm contact to trigger.

### 7.5.5. Filter Replacement Alarm Mode

Once the nitrogen generator has been running for 1,000 hours or more, the filter replacement alarm will activate the audible buzzer, alarm contact, and flash "**FILTER CHANGE**" on the controller's 7-segment display. Replace the filters according to Section 9 Maintenance. After replacing the filter elements, press and hold the Filter Change Reset button (Down Button) for 7 seconds. Screen will show "**FILTER RESET**" and audible beep will confirm that the time is reset, and the filter alarm will shut off if it is active. (Note: resetting this will also trigger the Customer Alarm Relay for one second).

### 7.5.6. Communication

#### (1) (Modbus RTU)

Modbus (RTU) is optional feature our generator offers to our customer to monitor the unit from BMS (Building Management System).

MODBUS communication can be set up to retrieve real time data. The nitrogen generator MODBUS Communication settings are as follows:

- Protocol: RTU
- Slave ID: 1
- PLC Controller: Slave
- Bud rate: 119200
- Data Bits: 8
- Parity: none
- Stop Bits: 2



See MODBUS addressing table below:

Function	Data Type	Modbus RTU Address	Units/Status	Read/Write
Running / Standby	BOOL	00012	0=Standby, 1=Running	R
Common Alarm	BOOL	00004	1=Good, 0=Alarm	R
BlastOff Alarm	BOOL	00015	0=Good, 1=Alarm	R
Bypass Alarm	BOOL	10005	1=Good, 0=Alarm	R
N2 Low Tank Pressure Alarm	BOOL	10004	1=Good, 0=Alarm	R
Filter Alarm	BOOL	00029	0=Good, 1=Alarm	R
Filter Reset Confirm	BOOL	00031	0=Good, 1=Alarm	R
Filter Hours	Register	40019	xxxxx.x / hours	R

## (2) Analog output (4-20 OUT)

Another useful and optional feature of (FPS) Reliable System units an analog signal output (4-20 mA) for current readings of different data points as follow:

- (i) Ambient temperature “4-20 out dEgr.F”
- (ii) Oxygen content (percent) “4-20 out p.CEnt”
- (iii) Oxygen content (ppm) “4-20 out trACE”
- (iv) Supply Pressure “4-20 out prEss”

To setup the analog out:

- 1) Hold the (Set Button) for 5 seconds Passcode Screen will pop up
- 2) Press the (Set Button) one time to activate data entry, Enter (6557) using the (Up and Down buttons)
- 3) Press the (ENT Button) to confirm the entry.

It will bring (Hold Set) Screen, press (NEXT) button to get to the analog output screen “4-20 out”, Using the (up and down buttons) buttons to change type of sensor, to confirm press (Set button). To exits menu press (Next button) to get back to main screen “running or standby”.

**Note: For analog output standard units (without advanced options) only will offer ambient temperature signal, check appendix A.**

## 8. Start-up Procedures

### 8.1. Start-up Procedures

Use caution when working with pressurized gas, and install all fittings and gas lines correctly. Always leak check (see 8.2 *Checking for Leaks* section) every line before using the system.

---

*Note: Line leaks will cause the N<sub>2</sub>-Blast<sup>®</sup> FPS-900-RS to run excessively, shortening its life and possibly causing excessive wear on the compressor.*

---

The system documentation package comes with an installation layout drawing. For electronic copies, please contact your local distributor. Review the complete installation layout drawing before installing and operating the system. Ensure that you follow the correct installation drawing per your system's design. In some cases, a nitrogen bypass system for pre-filling is required to meet code. If the system requirements are more complex, please consult the sales representative or equipment installer for more detailed instructions.

---

*Note: The N<sub>2</sub>-Blast<sup>®</sup> comes with 1/2" NPT Female inlet and outlet fittings. Use Teflon tape or similar on all fittings to prevent leakage. When connecting an external air compressor, complete the startup procedures per manufacturer before starting the nitrogen generator.*

---

**The following are standard startup instructions:**

1. Complete the installation procedures from Reliable Unit Installation Instructions. (See section 5)
2. Check that the power connection is correct.
3. Turn the 3-way ball valve on the system output to the "Bypass" position.

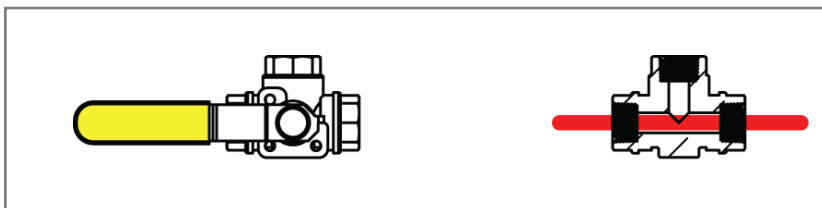

**Figure 3: 3-way valve in bypass position**

4. Open the inlet ball valve on the nitrogen storage tank if it is closed.
5. Push the power button on the top left of the cabinet to the "On" position (up). The air compressor will power on if the storage tank is under pressurized. If neither the compressor nor PLC display power on, check the wiring and supply power to the generator.
6. Once the system is running, the pressure gauge will increase to 65-70 PSIG within 30 minutes or less. While it is running, check the system for leaks to ensure proper functionality.

- a) Once it reaches 65-70 PSIG, the system will enter “Standby” mode and automatically shut off the internal air compressor. Check the controller on the control panel for the “**STANDBY**” display.
  - b) Once in standby, note the pressure reading on the tank pressure gauge. Monitor the pressure for the next 5 minutes for any loss in pressure. If there is a pressure drop, check for leaks around connection fittings, otherwise proceed to the next step.
7. Switch the 3-way ball valve on the system output to the “Nitrogen Out” position and the system will fill with nitrogen.

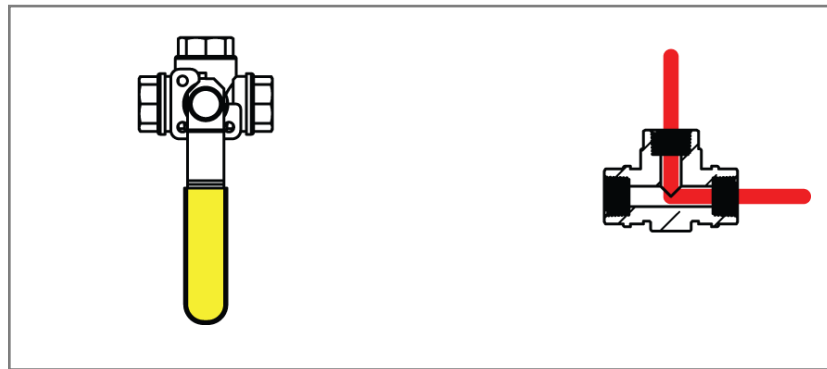

**Figure 4: 3-way valve in N<sub>2</sub> out position**

8. Completely fill the storage tank and then allow the nitrogen generator to go into standby mode again.
9. Once in standby mode, monitor the tank pressure gauge for 5 minutes to ensure that no significant leaks are in the sprinkler system.

## 8.2. Checking for Leaks

The BlastOff® provides early warning alarms for potential leakage. With a suspected leak, first listen for leaks and then spray soapy water around the connections. When a leak occurs, isolate the area and relieve pressure before working on it. Fix the leaking part and return the system back to operation. If no leak is heard (or no bubbles are seen), turn off the unit and try isolating sections to see if there’s a pressure loss. Consult with your installer if you cannot find the leakage area.

### 8.2.1. To determine if the leak is between the Generator and the Nitrogen Tank:

1. With the unit powered on, close off both ball valves on the nitrogen tank. Note the storage tank pressure.
2. Allow the system to continue running. Within 10 minutes or less, the system should reach the “Standby” mode.
3. Wait 5 minutes and if the system remains in “standby” mode, then the leak is after the nitrogen generator. Read the nitrogen tank pressure and if the pressure has changed, the leak is within

the storage tank fittings. If the nitrogen tank pressure did not change, check the sprinkler piping in the building for leaks.

4. Returning to “run” mode indicates the leak is within the cabinet. Check lines back to the tank.

## 9. Maintenance

**WARNING: Whenever doing any maintenance on the system, make sure to power down the system. Remove the front cover to gain access to the filters.**

---

*Note: Annual Filter Replacement Kit (part# FRP-007) and a Preventative Maintenance Box are available for this unit. Call (888)526-6284 or email [service@southteksystems.com](mailto:service@southteksystems.com)*

---

### 9.1. Air Intake Filter

The integrated air compressor of the *N<sub>2</sub>-BLAST®* FPS-900-RS has an air intake pre-filter. It prevents particles from entering the compressor housing and damaging internal components. Replace this filter once per year or every 1,000 hours, whichever comes first. To do so, remove the pre-compressor filter cap by twisting it clockwise. Remove the old element and use a clean dry cloth to clean the filter bowl before installing the new element.

### 9.2. Air Filter replacement

The particulate and coalescing filters are designed to capture particulate and moisture prior to entering the rest of the system. These filters need to be replaced once per year or every 1,000 hours, whichever comes first.

#### **Follow these instructions to replace filters:**

1. Turn off the unit and remove the cabinet cover, by removing four (4) screws.
2. Locate the air filters on the bracket in the middle of the cabinet. See **Figure 5**.
3. Make sure the filters are completely depressurized by checking the pressure gauge.
4. Remove two filter bowls. Do so by turning them counter-clockwise.
5. After removing the filter bowls, rinse debris out of the bowls with warm water.
6. Dry the bowls with a clean dry cloth and replace old O-rings with the new ones provided.
7. Change the filter elements:
  - a) Particulate Element - Pull the plastic element housing out of the filter bowl. Twist off the black plastic cover and pull off the particulate element. Lubricate the O-rings and seals if needed. Install the new element in the reverse order.
  - b) Coalescing Element - Twist the coalescing element counter-clockwise. Lubricate the O-rings and seals if needed. Install the new element in the reverse order.
8. After replacing all elements, O-rings and cleaning the bowls, install the bowls back to their corresponding filter housings.
9. After replacing the filters, put the front cover back on and power on the unit. Once powered up, the air compressor will turn on and start producing nitrogen. Check the filter bowls for leaks.

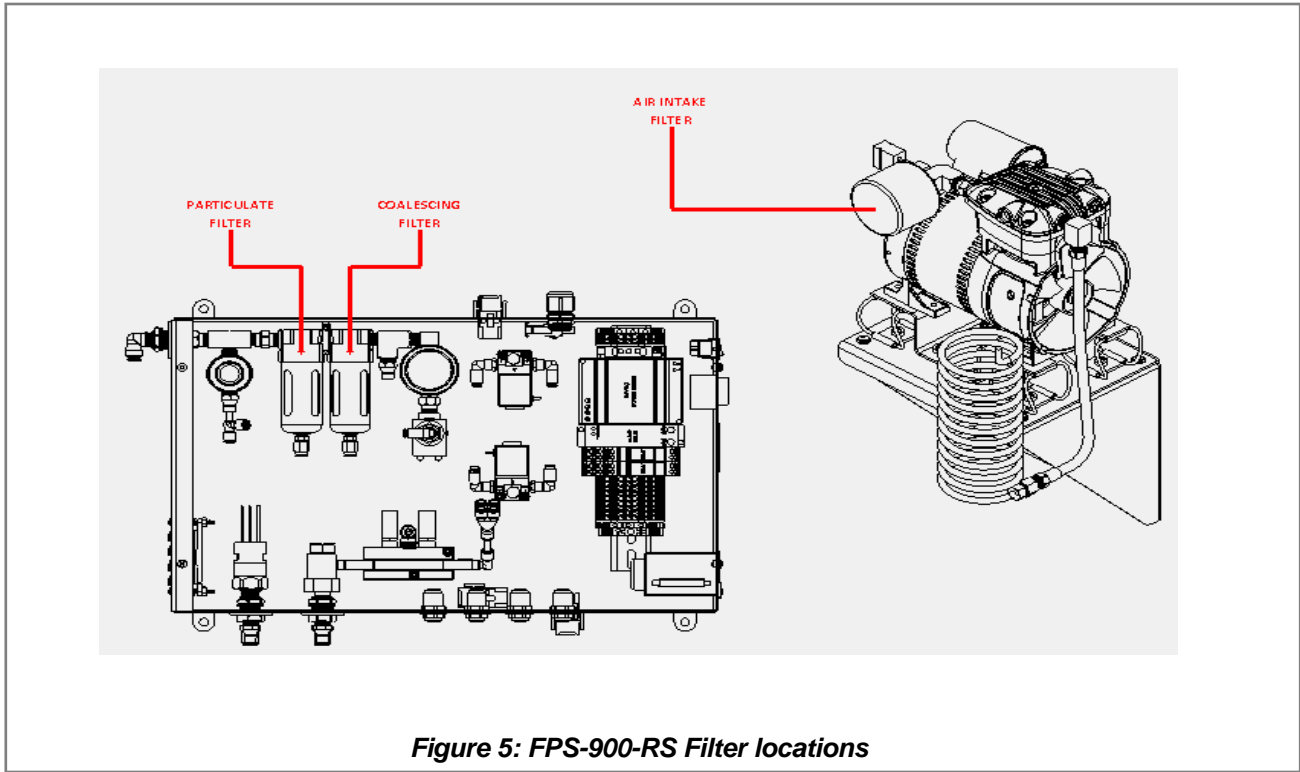

## **10. Key Contacts**

Contact your local provider/installer for any questions about the performance and/or maintenance of the system. They will be best suited to answer your questions and your quickest solution on any issues you may have.

If they cannot be reached, contact the manufacturer at:

South-Tek Systems, LLC  
3700 U.S. Highway 421 North  
Wilmington, NC, 28401

Tel: (888) 526-6284

Email: [Info@southteksystems.com](mailto:Info@southteksystems.com)

<http://www.southteksystems.com/>

## 11. FAQs

### 11.1. Power Issues

If the *N<sub>2</sub>-BLAST*<sup>®</sup> FPS-900-RS does not have power, the production and storage of nitrogen will become apparent once the storage pressure drops.

- Check the power cord.
- Has the building's circuit breaker or GFCI tripped? Locate the breaker and reset. If breaker continues to trip, the circuit may be overloaded.

### 11.2. Pressure Issues

The *N<sub>2</sub>-BLAST*<sup>®</sup> FPS-900-RS will produce and store Nitrogen at 70 (+/-3) psig. Once the storage tank reaches 70 (+/-3) psig, the system will go into Standby Mode. When the pressure drops by about 7-10 psig, the system should go into Run Mode and begin to refill the storage tank. If the system is out of specifications, the location of the issue must be identified. Then contact the manufacturer or factory trained technician.

#### **Nitrogen Pressure Check:**

The pressure gauge on the front of the cabinet should be between 60-70 psig. If the pressure is low, check the following:

- Check the power.
- Find out if fire protection system is being tested.
- Check for leaks throughout system.

Refer to section **8.2 *Checking for Leaks.***

### 11.3. Gas Leaks

As with any gas system, only use a spray bottle on non-electrical equipment to find leaks. Fix or replace leaking fittings or hoses. Push-to-connect fittings will show bubbles and typically have up to a 5ccm acceptable leakage rate. Contact your local provider / installer for help.



## APPENDIX A: Advanced Options

An advance options can be added to the N2-BLAST® FPS-900-RS systems upon the customer request, such as:

1. Oxygen analyzer - to monitor the oxygen content in the system, with the ability to add set points and alarms to trace the oxygen content in system and maintain the purity of the nitrogen gas.

There is two sensor options for this feature:

- Max O2% (100% Range sensor) “O2 PCENT”
- PPM Trace (Parts per Million sensor) “O2 TRACE”

2. Pressure transducer “PRESSURE” - to have more control of the unit cut-in and cut-out pressure, pressure set point and low pressure alarm.

An extra screens will be added automatically to main screens for each sensor, and show the current values.

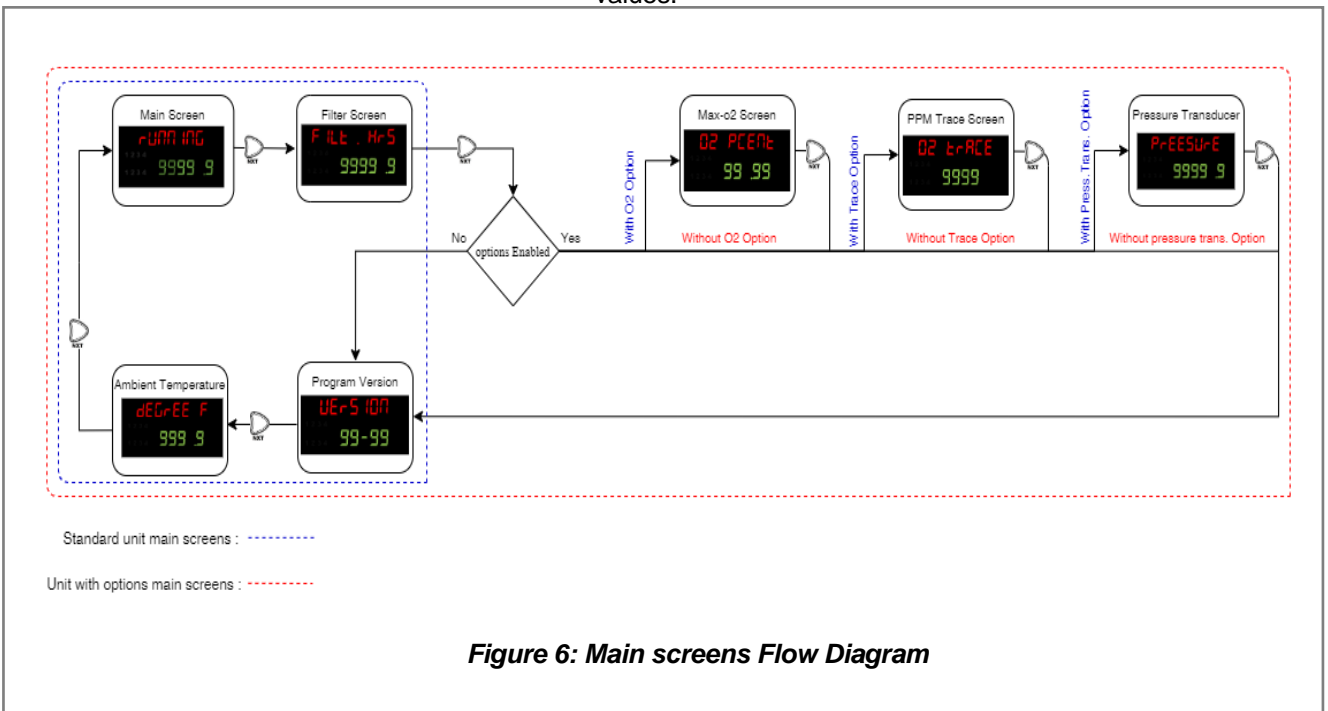

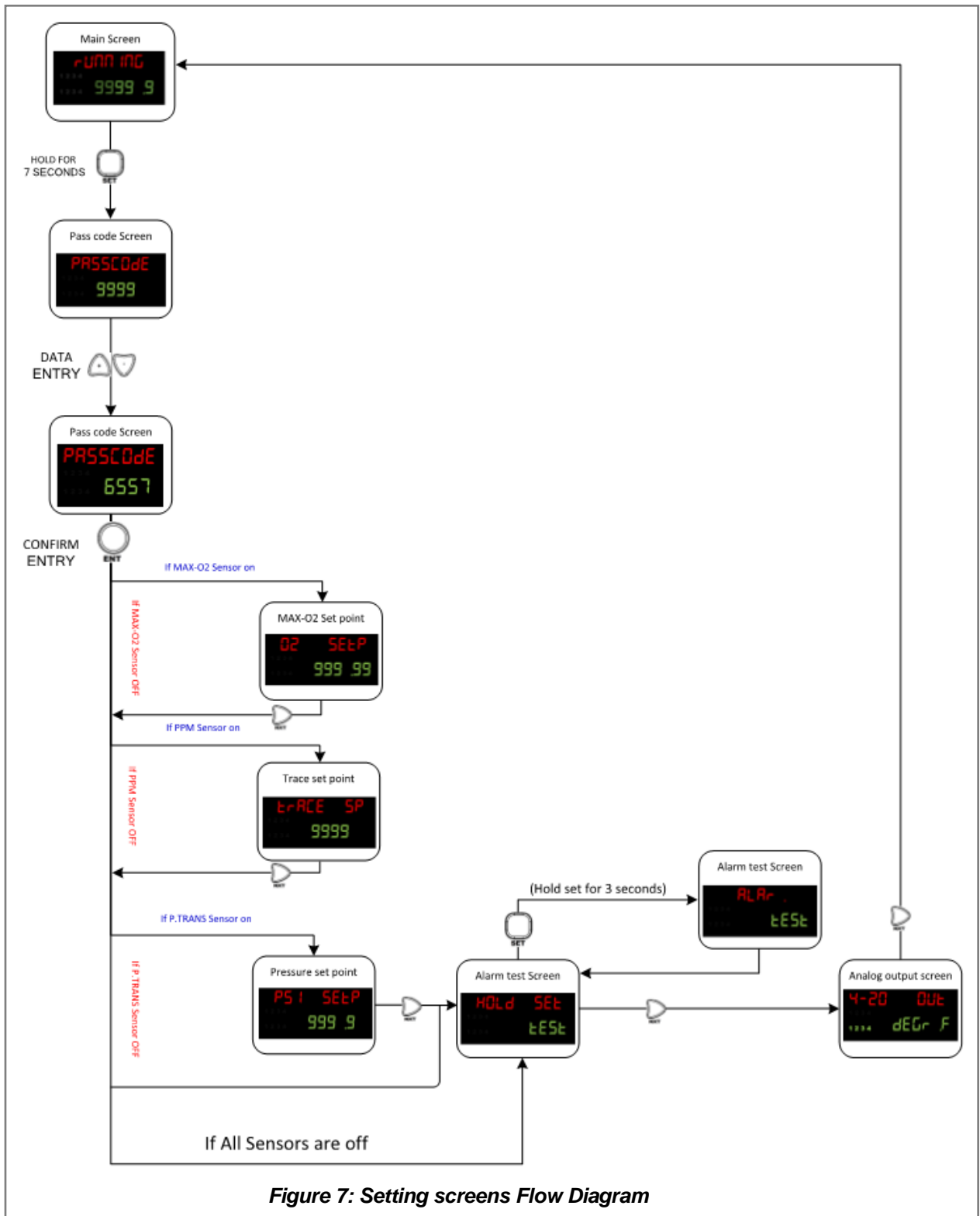

**Figure 7: Setting screens Flow Diagram**

If any of these sensor start alarming an alarm screen will start switches at intervals of 1 second to the current display and it will trigger the buzzer and common alarm contact.

Modbus (RTU) Table for optional sensors:

Function	Data Type	Modbus RTU Address	Units/Status	Read/Write
High oxygen Alarm (Percent)	BOOL	00108	0=Good, 1=Alarm	R
High oxygen Alarm (PPM)	BOOL	00117	0=Good, 1=Alarm	R
Low Pressure Alarm	BOOL	000165	0=Good, 1=Alarm	R
Pressure cut-in	Double integer	40144	xxx.x	R/W
Pressure cut-off	Double integer	40146	xxx.x	R/W
Current pressure	Double integer	30139	xxx.x	R
Current oxygen(percent)	Double integer	40294	xxx.xx	R
Current oxygen(PPM)	Double integer	30119	xxxxx	R

Note: all these options can be added all at once on same unit, for more information contact one of our sales team member.

## APPENDIX B: WARRANTY

The *N<sub>2</sub>-BLAST*<sup>®</sup> FPS-900-RS systems are warrantied against any defects in workmanship and materials for 12 months, or 1,000 hours (whichever comes first) from the date of shipment from South-Tek Systems. The purchaser has the liability to ensure that the system is fully inspected upon delivery and shall contact the appropriate shipping company to make any claims on damaged goods due to transit within that shipping company's policies. If the system is received with defects that are not due to shipping, a written claim should be submitted to South-Tek Systems within 1 week of receiving the shipment. South-Tek Systems can deny all other claims at their discretion. All warranty work shall be done at a South-Tek Systems facility or at an Authorized Service Center. Only work performed by factory trained and authorized personnel is covered under warranty. Any part that is returned/repaired/replaced under warranty may be remanufactured or changed to a different specification at the factory's option. Any work performed by an unauthorized person/company or usage of non-factory parts may void all warranties to the product. Any item not manufactured by South-Tek Systems may carry its own warranty from its manufacturer and will be warrantied by that manufacturer. All parts that need to be returned should be announced. Any item(s) that is returned to South-Tek Systems without an RMA number (return authorization number) may be denied and returned to the sender. Contact the factory for RMA #'s, prior to return shipment. South-Tek Systems is not liable for damages caused by normal wear and tear, water, fire, erosion, corrosion, explosion, misuse, oil/gas vapors or unauthorized modifications. South-Tek Systems is not liable for any losses, damages, or cost of delays, including incidental or consequential damages. There are no warranties or guarantees, expressed or implied, including the warranties of merchantability or fitness for a particular purpose or use, other than those warranties expressed herein.

For Claims, contact South-Tek Systems, LLC. at:  
tel (888) 526-6284 fax (910) 332-4178  
Email: [info@southteksystems.com](mailto:info@southteksystems.com)

Or write to:  
South-Tek Systems, Warranty Claims,  
3700 U.S. Highway 421 North, Wilmington, NC 28401

RELEASED TO PRODUCTION

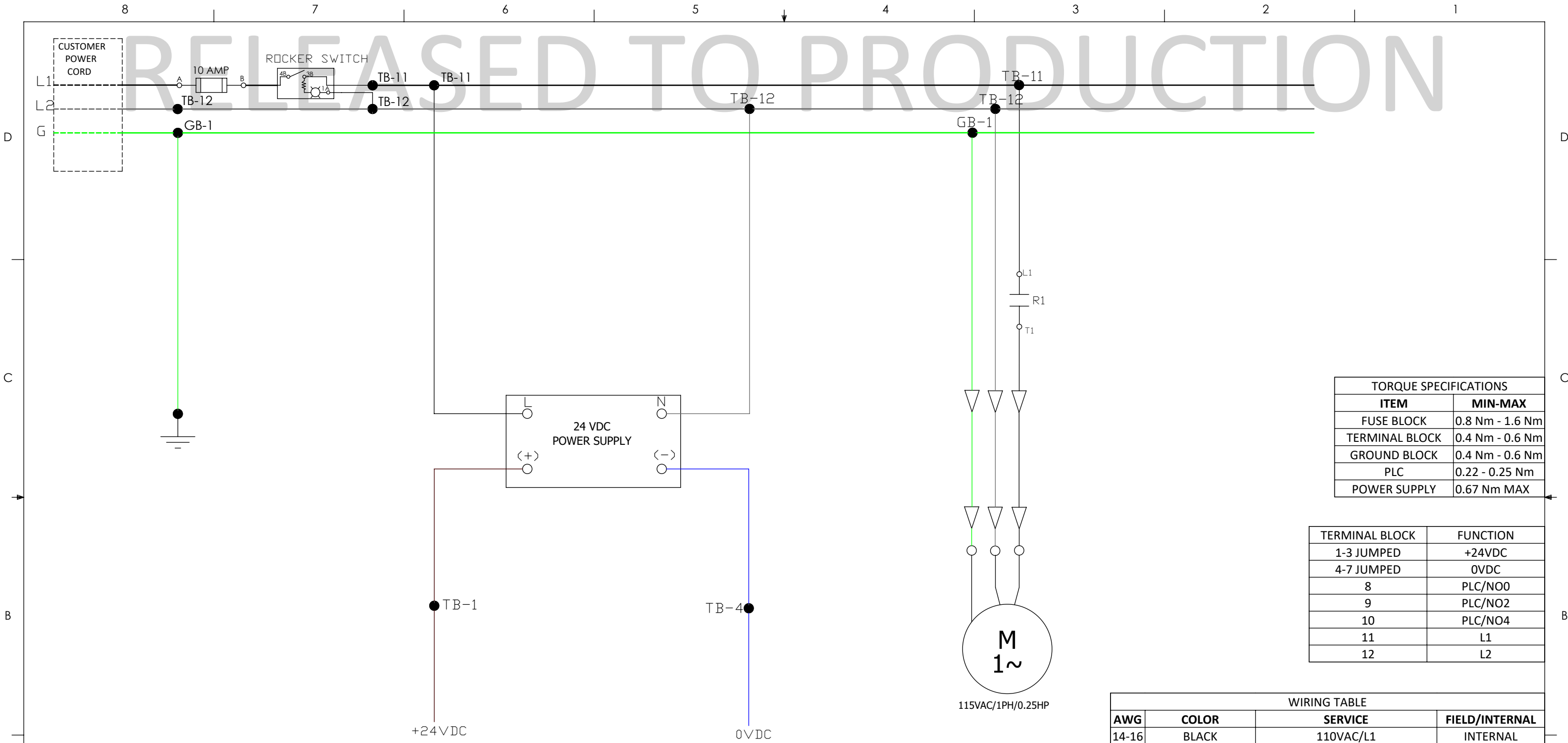

TORQUE SPECIFICATIONS	
ITEM	MIN-MAX
FUSE BLOCK	0.8 Nm - 1.6 Nm
TERMINAL BLOCK	0.4 Nm - 0.6 Nm
GROUND BLOCK	0.4 Nm - 0.6 Nm
PLC	0.22 - 0.25 Nm
POWER SUPPLY	0.67 Nm MAX

TERMINAL BLOCK	FUNCTION
1-3 JUMPED	+24VDC
4-7 JUMPED	0VDC
8	PLC/NO0
9	PLC/NO2
10	PLC/NO4
11	L1
12	L2

WIRING TABLE			
AWG	COLOR	SERVICE	FIELD/INTERNAL
14-16	BLACK	110VAC/L1	INTERNAL
14-16	WHITE	110VAC/L2	INTERNAL
16-18	BROWN	+24VDC	INTERNAL
16-18	BLUE	0V	INTERNAL
16-22	GRAY/RED	SIGNAL	INTERNAL
14-16	ANY	110VAC	FIELD

REV	TASK#	SHEET	DESCRIPTION	DATE	DRAWN	APPR.
03	10483	-	UPDATED TO INCLUDE DRY CONTACT WIRE COLOR, LENGTHS	07/09/21	SDA	RAB
02	10467	-	SWITCH OUT TWIX PLC BLOCK	02/16/21	APA	PJS
01	10404	-	NEW PLC, NEW DRAWING FORMAT	03/20/19	NTA	KLM

REVISIONS: ONLY THE LATEST 3 REVISIONS WILL BE SHOWN. OLDER REVISIONS CONSOLIDATED AND FILED.

**South-Tek Systems**

**PROPRIETARY AND CONFIDENTIAL**  
 THE INFORMATION CONTAINED IN THIS DRAWING IS THE SOLE PROPERTY OF SOUTH-TEK SYSTEMS. ANY REPRODUCTION IN PART OR AS A WHOLE WITHOUT THE WRITTEN PERMISSION OF SOUTH-TEK SYSTEMS IS PROHIBITED.

**MATERIAL:**  
**FINISH:**  
**WEIGHT:**

**UNLESS OTHERWISE SPECIFIED DIMENSIONS ARE IN INCHES**

ANGLES	X.	.X	.XX	.XXX	X/X<10'	X/X>10'
±.5°	±1	±.2	±.03	±.005	±1/16	±1/8

**ELECTRICAL SCHEMATIC, RELIABLE INTEGRATION**

**ELECTRICAL SCHEMATICS**

**NUMBER: ES-FPS-00900-RS**

DRAWN: PJS	APPROVED: SDA
DATE: 06/18/19	DATE: 06/28/19
SCALE: 1:1	SHEET: 1 OF 2
SIZE: B	REVISION: 03

# RELEASED TO PRODUCTION

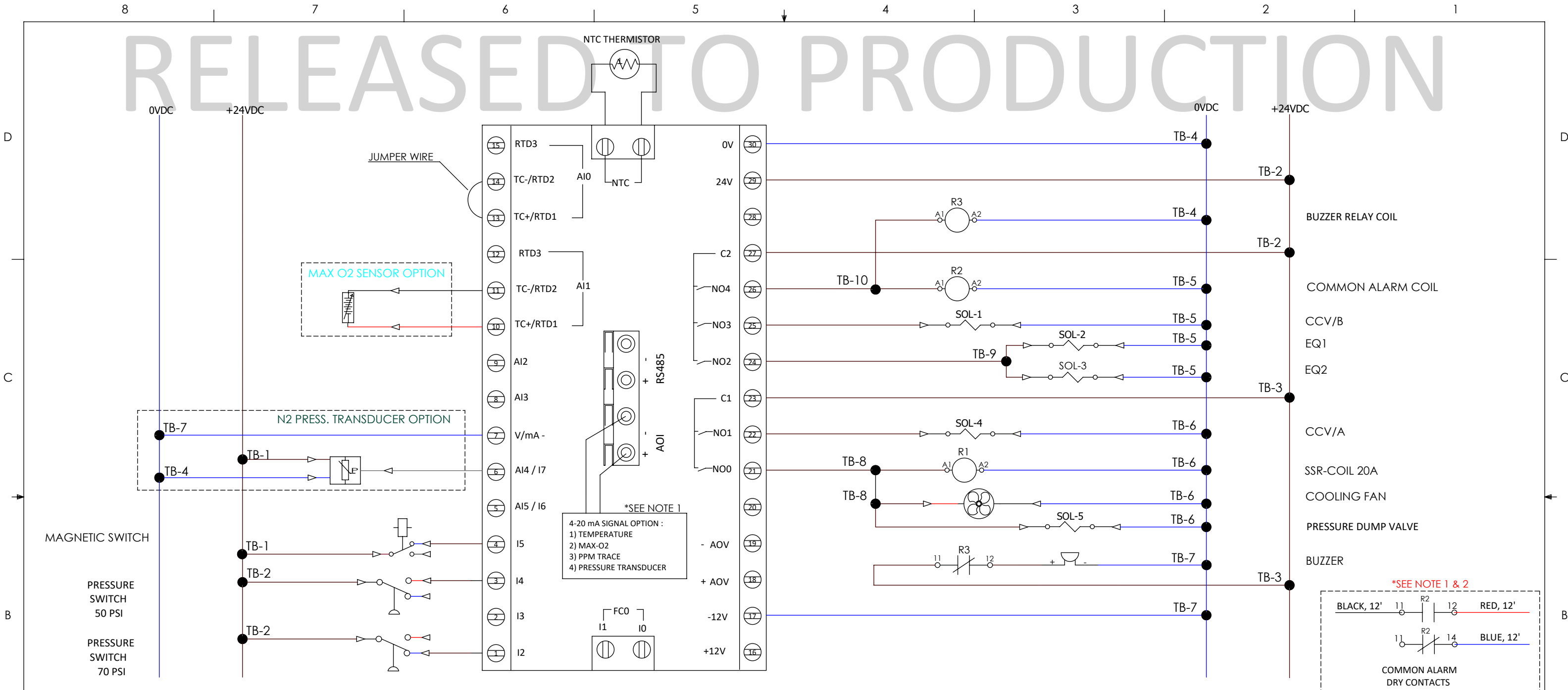

TERMINAL BLOCK	FUNCTION
1-3 JUMPED	+24VDC
4-7 JUMPED	0VDC
8	PLC/NO0
9	PLC/NO2
10	PLC/NO4
11	L1
12	L2

TORQUE SPECIFICATIONS	
ITEM	MIN-MAX
FUSE BLOCK	0.8 Nm - 1.6 Nm
TERMINAL BLOCK	0.4 Nm - 0.6 Nm
GROUND BLOCK	0.4 Nm - 0.6 Nm
PLC	0.5 Nm MAX
POWER SUPPLY	0.67 Nm MAX

WIRING TABLE			
AWG	COLOR	SERVICE	FIELD/INTERNAL
16-18	BROWN	24 + VDC	INTERNAL
16-18	BLUE	0V	INTERNAL
16-22	RED/BLACK	MV SIGNAL	INTERNAL
16-22	WHITE	1-5V SIGNAL	INTERNAL
16-22	ANY	4-20 MA SIGNAL	FIELD

**NOTES:**  
 (1) OPTIONAL COMMON ALARM CONNECTION FOR (BYPASS, BLASTOFF, LOW N2 PRESSURE, FILTER, & POWER LOSS ALARMS) FOR FIRE PANEL OR SIMILAR MONITORING DEVICE.  
 (2) IF AN ALARM IS ACTIVE: 11-14 WILL BE OPEN, 11-12 WILL BE CLOSED.  
 (3) ANALOG OUTPUT IS USER CONFIGURABLE; SEE O&M MANUAL FOR DETAILS

REV	TASK#	SHEET	DESCRIPTION	DATE	DRAWN	APPR.
03	10483	-	UPDATED TO INCLUDE DRY CONTACT WIRE COLOR, LENGTHS	07/09/21	SDA	RAB
02	10467	-	SWITCH OUT TWIX PLC BLOCK	02/16/21	APA	PJS
01	10404	-	NEW PLC, NEW DRAWING FORMAT	03/20/19	NTA	KLM

**REVISIONS: ONLY THE LATEST 3 REVISIONS WILL BE SHOWN. OLDER REVISIONS CONSOLIDATED AND FILED.**

**South-Tek Systems**

PROPRIETARY AND CONFIDENTIAL  
 THE INFORMATION CONTAINED IN THIS DRAWING IS THE SOLE PROPERTY OF SOUTH-TEK SYSTEMS. ANY REPRODUCTION IN PART OR AS A WHOLE WITHOUT THE WRITTEN PERMISSION OF SOUTH-TEK SYSTEMS IS PROHIBITED.

**ELECTRICAL SCHEMATIC, RELIABLE INTEGRATION**

**ES-FPS-00900-RS**

DATE: 06/18/19  
 SCALE: 1:1  
 SHEET: 2 OF 2  
 REVISION: 03

LINE LEGEND	
	DRY AIR IN
	N2 PRODUCT TO TANK
	N2 OUT TO AMD
	DRAIN LINES

GA-FPS-00900-RS, GENERAL ARRANGEMENT, SYSTEM FLOW AND CONNECTIONS, 03					
ITEM #	NUMBER	DESCRIPTION	QTY.	SHEET	
E1	FPS-00900-RS-01	CABINET ASSEMBLY, RELIABLE	1	2	
E2	FPS-00900-RS-02	COMPRESSOR ASSEMBLY, RELIABLE	1	3	
E3	FPS-00900-RS-03	SIEVE BED ASSEMBLY, RELIABLE	1	4	
E4	FPS-00900-RS-04	TANK ASSEMBLY, RELIABLE	1	5	
E5	105201	N2-BLAST LABEL FOR RELIABLE INTEGRATION CABINET	1	6	
E6	800097	24", 16 GAUGE, 3 WIRE, WIRING HARNESS	1	-	
E7	103051	0.375 OD NATURAL POLYETHYLENE, PER INCH	48	-	
E8	100500	16.3 BLACK INSULATED CABLE, PER FT	16	-	
E9	102973	0.250 OD NATURAL POLYETHYLENE, PER INCH	20	-	
E10	103047	0.500 OD NATURAL POLYETHYLENE, PER INCH	7	-	

ELECTRICAL CONNECTIONS		
ITEM #	DESCRIPTION	SERVICE
C1	3 PIN PLUG, UNIVERSAL MALE MATE-N-LOK	COMPRESSOR
C2	CABLE CORD GRIP, W/16' OF 16-3 CABLE	MAIN POWER
C3	1/2" TRADE SIZE CONDUIT KNOCKOUT	ALARM
C4	3 PIN PLUG, UNIVERSAL MALE MATE-N-LOK	MAGNETIC SWITCH

FIELD CONNECTIONS	
ITEM #	DESCRIPTION
1	1/4" OD PTC
2	3/8" OD PTC
3	1/2" NPT M
4	1/2" NPT F
5	1/4" NPT F
6	1/2" OD PTC

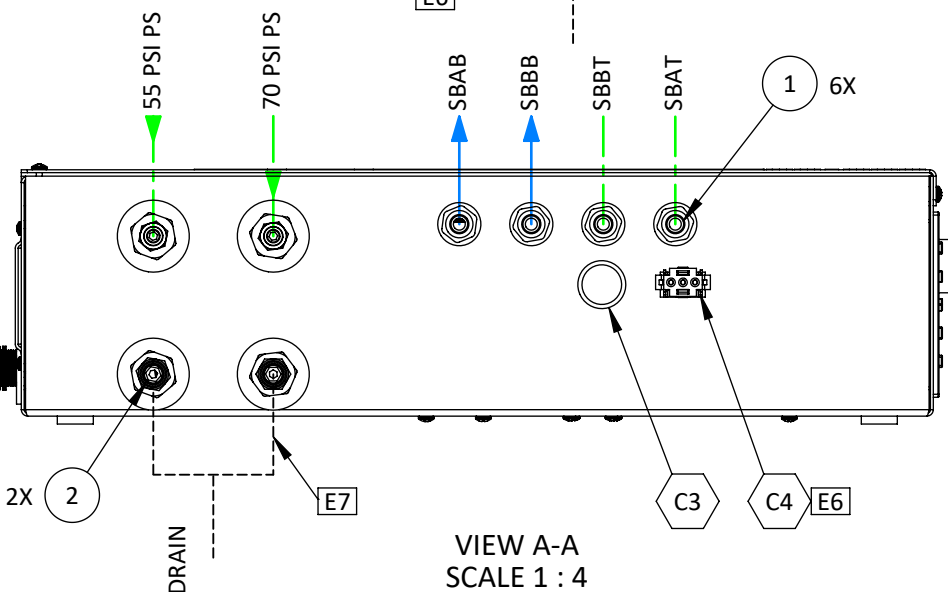
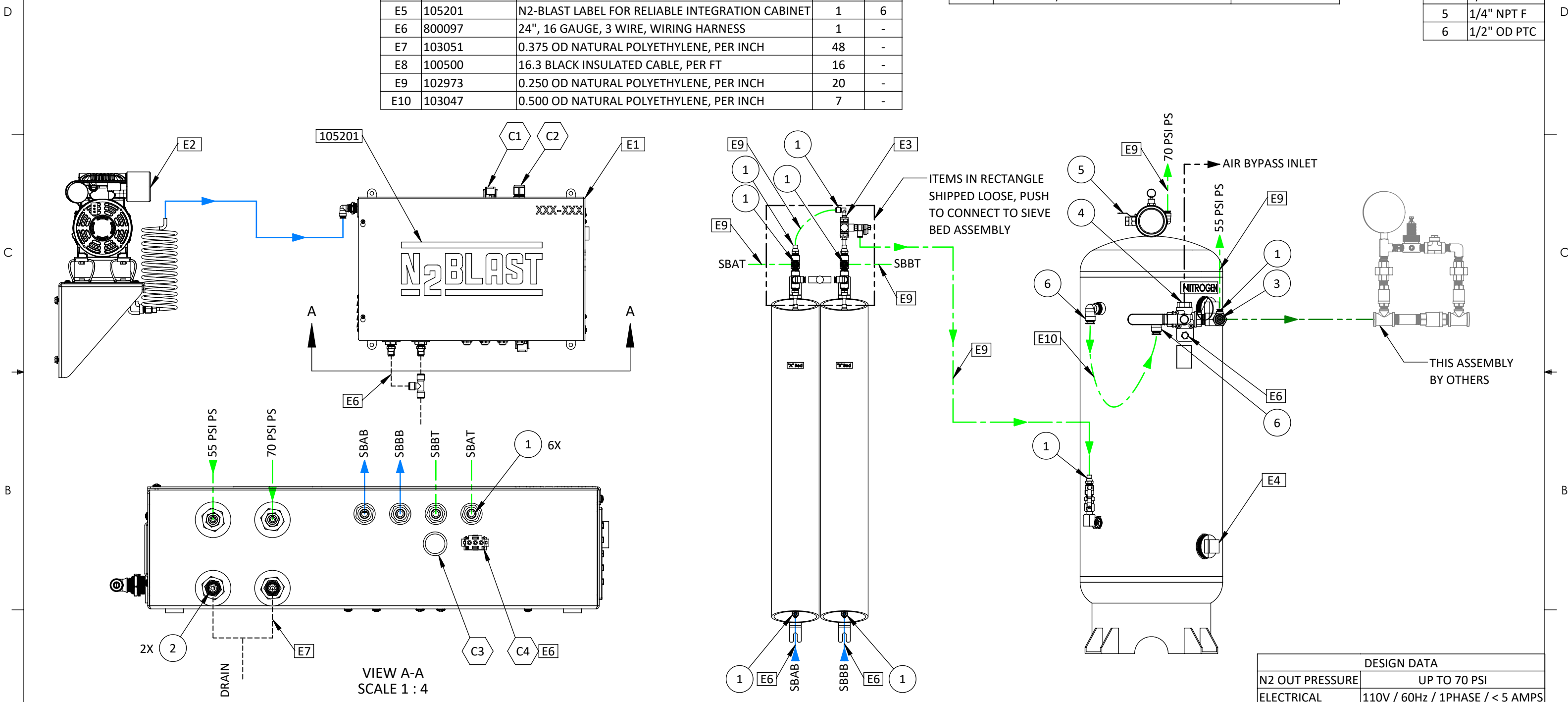

DESIGN DATA	
N2 OUT PRESSURE	UP TO 70 PSI
ELECTRICAL	110V / 60Hz / 1PHASE / < 5 AMPS

REV	TASK#	SHEET	DESCRIPTION	DATE	DRAWN	APPR.
03	10483	-	CLARIFYING WIRING DESCRIPTION	07/12/21	SRG	SDA
02	10481	-	WIRING HARNESS ADDED TO BOM, CHANGED 0.25"NPT X 0.375"PTC ELBOW TO 0.25"NPT X 0.25"PTC ELBOW	06/08/21	SRG	SDA
01	10404	-	UPDATED WITH NEW PLC	03/11/20	SRG	PJS

REVISIONS: ONLY THE LATEST 3 REVISIONS WILL BE SHOWN. OLDER REVISIONS CONSOLIDATED AND FILED.

**South-Tek Systems**

PROPRIETARY AND CONFIDENTIAL  
THE INFORMATION CONTAINED IN THIS DRAWING IS THE SOLE PROPERTY OF SOUTH-TEK SYSTEMS. ANY REPRODUCTION IN PART OR AS A WHOLE WITHOUT THE WRITTEN PERMISSION OF SOUTH-TEK SYSTEMS IS PROHIBITED.

MATERIAL:  
FINISH:  
WEIGHT:  
PROJECT NAME: RELIABLE  
NUMBER: GA-FPS-00900-RS

ANGLES	X.	.X	.XX	.XXX	X/X<10'	X/X>10'
±.5°	±1	±.2	±.03	±.005	±1/16	±1/8

**GENERAL ARRANGEMENT, SYSTEM FLOW AND CONNECTIONS**

SIZE: B  
SCALE: 1:8  
SHEET: 1 OF 6  
REVISION: 03

ITEM #	STS PART #	DESCRIPTION	QTY.
1	FPS-00900-RS-01	CABINET ASSEMBLY, RELIABLE	1

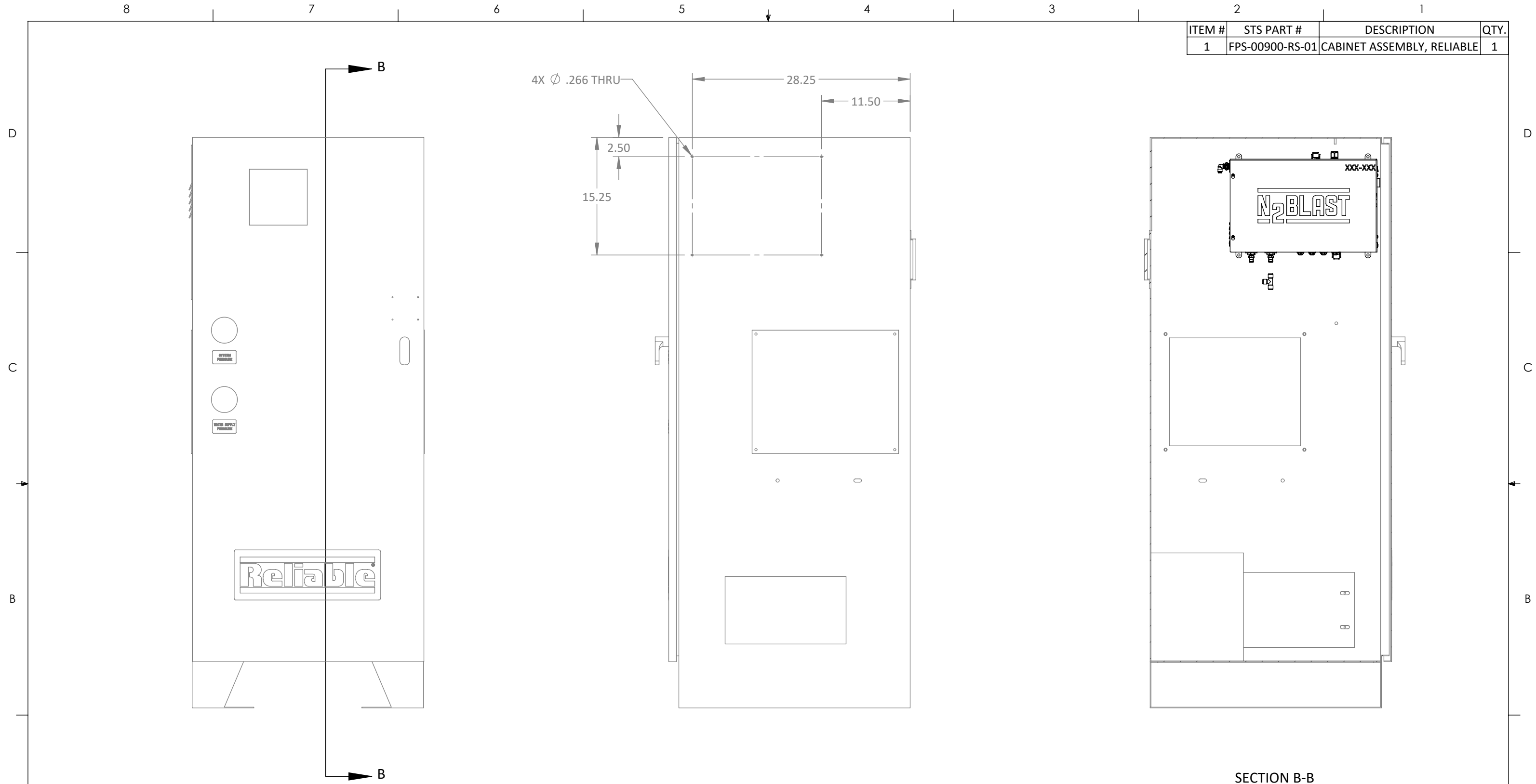

SECTION B-B

REV	TASK#	SHEET	DESCRIPTION	DATE	DRAWN	APPR.
03	10483	-	CLARIFYING WIRING DESCRIPTION	07/12/21	SRG	SDA
02	10481	-	WIRING HARNESS ADDED TO BOM, CHANGED 0.25"NPT X 0.375"PTC ELBOW TO 0.25"NPT X 0.25"PTC ELBOW	06/08/21	SRG	SDA
01	10404	-	UPDATED WITH NEW PLC	03/11/20	SRG	PJS

REVISIONS: ONLY THE LATEST 3 REVISIONS WILL BE SHOWN. OLDER REVISIONS CONSOLIDATED AND FILED.



**PROPRIETARY AND CONFIDENTIAL**  
THE INFORMATION CONTAINED IN THIS DRAWING IS THE SOLE PROPERTY OF SOUTH-TEK SYSTEMS. ANY REPRODUCTION IN PART OR AS A WHOLE WITHOUT THE WRITTEN PERMISSION OF SOUTH-TEK SYSTEMS IS PROHIBITED.

MATERIAL:						
FINISH:						
WEIGHT:			PROJECT NAME: RELIABLE			
UNLESS OTHERWISE SPECIFIED DIMENSIONS ARE IN INCHES						
ANGLES	X.	.X	.XX	.XXX	X/X<10'	X/X>10'
±.5°	±1	±.2	±.03	±.005	±1/16	±1/8

<b>GENERAL ARRANGEMENT, SYSTEM FLOW AND CONNECTIONS</b>			DRAWN: PJS	APPROVED: SDA
			DATE: 11/29/18	DATE: 11/29/18
		SIZE: B	SCALE: 1:12	SHEET: 2 OF 6
<b>GA-FPS-00900-RS</b>			<b>REVISION: 03</b>	



ITEM #	STS PART #	DESCRIPTION	QTY.
1	FPS-00900-RS-02	COMPRESSOR ASSEMBLY, RELIABLE	1

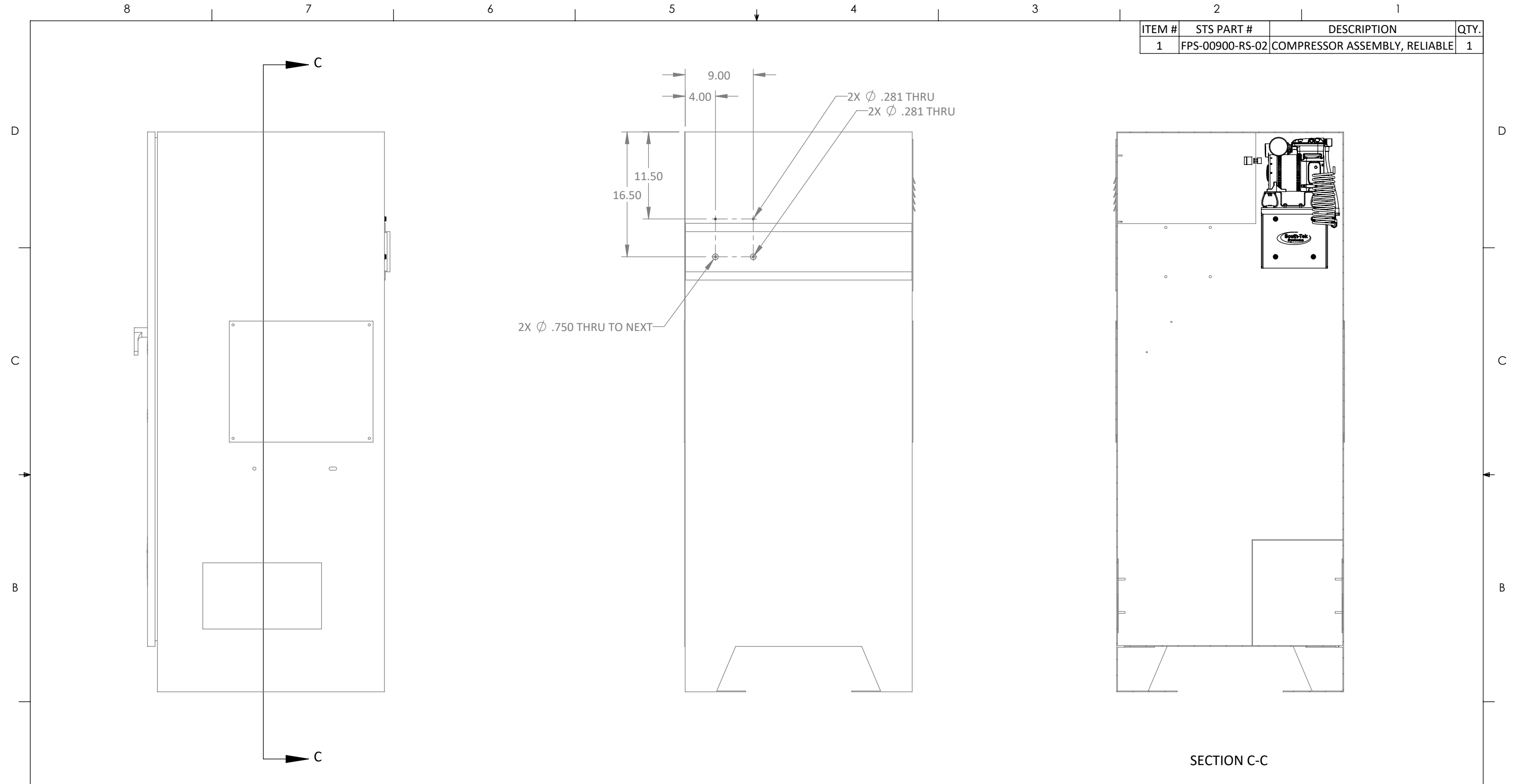

SECTION C-C

REV	TASK#	SHEET	DESCRIPTION	DATE	DRAWN	APPR.
03	10483	-	CLARIFYING WIRING DESCRIPTION	07/12/21	SRG	SDA
02	10481	-	WIRING HARNESS ADDED TO BOM, CHANGED 0.25"NPT X 0.375"PTC ELBOW TO 0.25"NPT X 0.25"PTC ELBOW	06/08/21	SRG	SDA
01	10404	-	UPDATED WITH NEW PLC	03/11/20	SRG	PJS

**South-Tek Systems**

**PROPRIETARY AND CONFIDENTIAL**  
THE INFORMATION CONTAINED IN THIS DRAWING IS THE SOLE PROPERTY OF SOUTH-TEK SYSTEMS. ANY REPRODUCTION IN PART OR AS A WHOLE WITHOUT THE WRITTEN PERMISSION OF SOUTH-TEK SYSTEMS IS PROHIBITED.

**MATERIAL:**  
**FINISH:**  
**WEIGHT:**

**UNLESS OTHERWISE SPECIFIED DIMENSIONS ARE IN INCHES**

ANGLES	X.	.X	.XX	.XXX	X/X<10'	X/X>10'
±.5°	±1	±.2	±.03	±.005	±1/16	±1/8

<b>GENERAL ARRANGEMENT, SYSTEM FLOW AND CONNECTIONS</b>		DRAWN: PJS	APPROVED: SDA
		DATE: 11/29/18	DATE: 11/29/18
PROJECT NAME: RELIABLE	SIZE: B	SCALE: 1:12	SHEET: 3 OF 6
NUMBER: GA-FPS-00900-RS		REVISION: 03	

ITEM #	STS PART #	DESCRIPTION	QTY.
1	FPS-00900-RS-03	SIEVE BED ASSEMBLY, RELIABLE	1

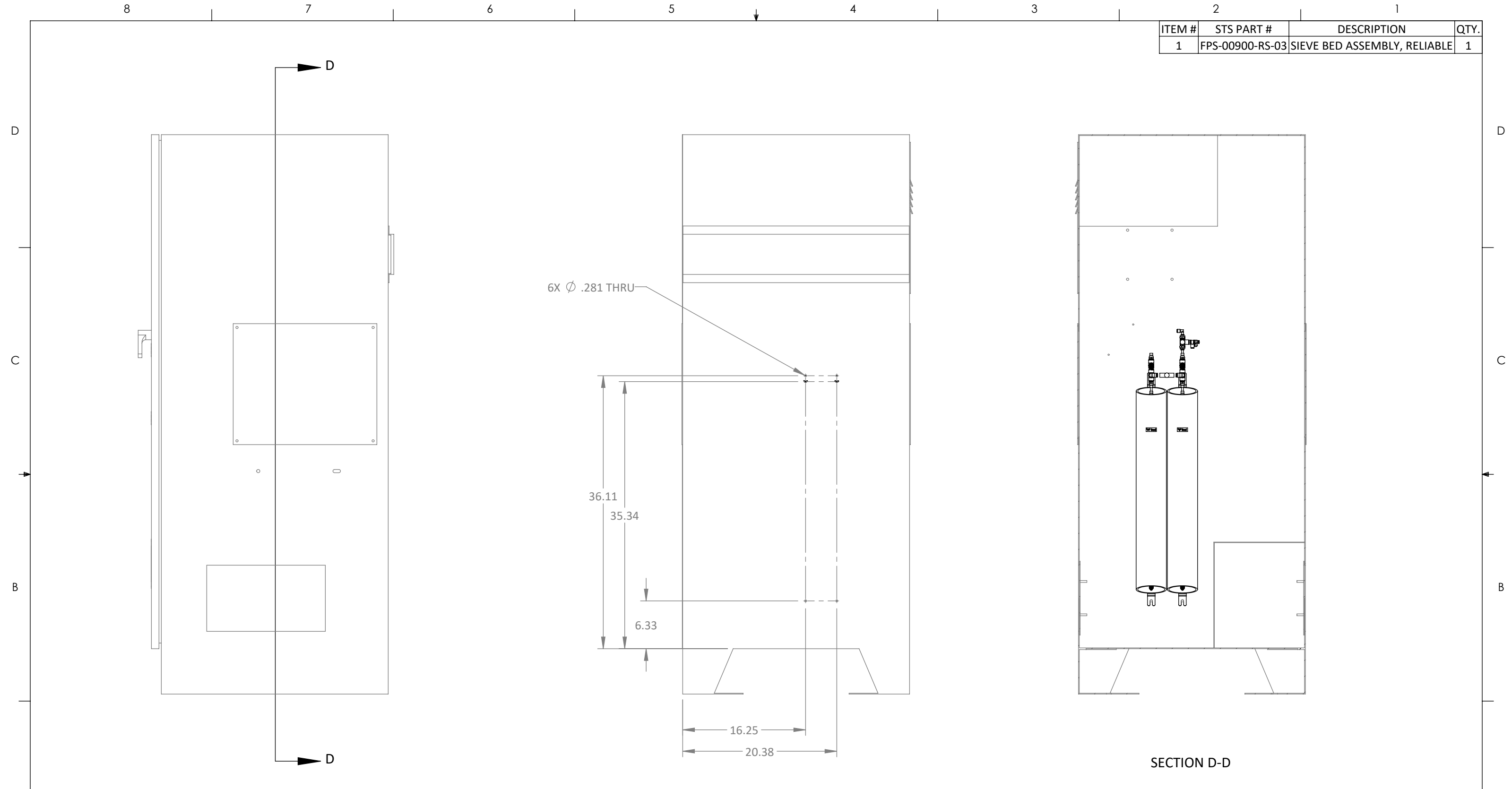

SECTION D-D

REV	TASK#	SHEET	DESCRIPTION	DATE	DRAWN	APPR.
03	10483	-	CLARIFYING WIRING DESCRIPTION	07/12/21	SRG	SDA
02	10481	-	WIRING HARNESS ADDED TO BOM, CHANGED 0.25"NPT X 0.375"PTC ELBOW TO 0.25"NPT X 0.25"PTC ELBOW	06/08/21	SRG	SDA
01	10404	-	UPDATED WITH NEW PLC	03/11/20	SRG	PJS

REVISIONS: ONLY THE LATEST 3 REVISIONS WILL BE SHOWN. OLDER REVISIONS CONSOLIDATED AND FILED.

**South-Tek Systems**

**PROPRIETARY AND CONFIDENTIAL**  
THE INFORMATION CONTAINED IN THIS DRAWING IS THE SOLE PROPERTY OF SOUTH-TEK SYSTEMS. ANY REPRODUCTION IN PART OR AS A WHOLE WITHOUT THE WRITTEN PERMISSION OF SOUTH-TEK SYSTEMS IS PROHIBITED.

**MATERIAL:**

**FINISH:**

**WEIGHT:**

**PROJECT NAME:** RELIABLE

**UNLESS OTHERWISE SPECIFIED DIMENSIONS ARE IN INCHES**

ANGLES	X.	.X	.XX	.XXX	X/X<10'	X/X>10'
±.5°	±1	±.2	±.03	±.005	±1/16	±1/8

**GENERAL ARRANGEMENT, SYSTEM FLOW AND CONNECTIONS**

**DRAWN:** PJS  
**APPROVED:** SDA

**DATE:** 11/29/18  
**DATE:** 11/29/18

**SIZE:** B  
**SCALE:** 1:12  
**SHEET:** 4 OF 6

**NUMBER:** GA-FPS-00900-RS

**REVISION:** 03

ITEM #	STS PART #	DESCRIPTION	QTY.
1	FPS-00900-RS-04	TANK ASSEMBLY, RELIABLE	1

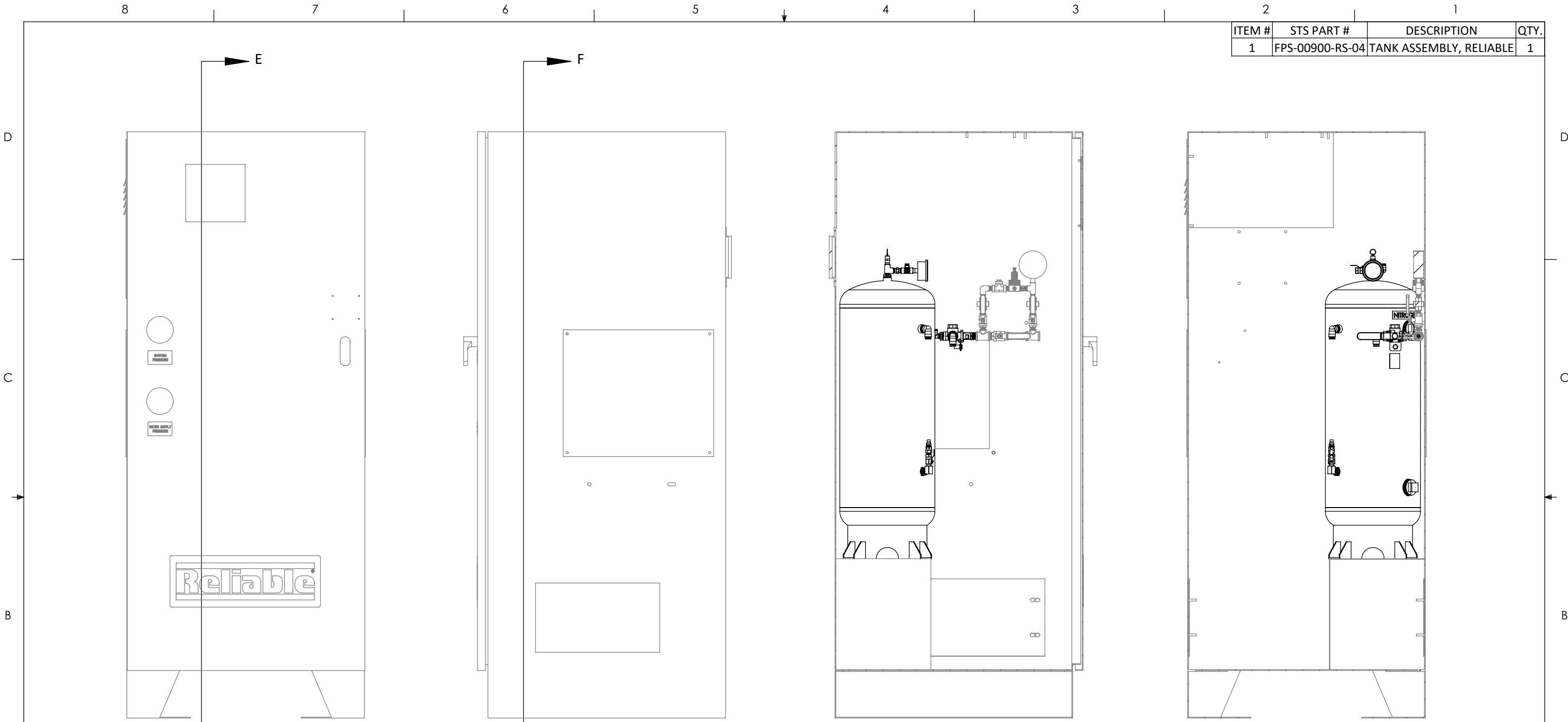

SECTION E-E

SECTION F-F

REV	TASK#	SHEET	DESCRIPTION	DATE	DRAWN	APPR.
03	10483	-	CLARIFYING WIRING DESCRIPTION	07/12/21	SRG	SDA
02	10481	-	WIRING HARNESS ADDED TO BOM, CHANGED 0.25"NPT X 0.375"PTC ELBOW TO 0.25"NPT X 0.25"PTC ELBOW	06/08/21	SRG	SDA
01	10404	-	UPDATED WITH NEW PLC	03/11/20	SRG	PJS



**PROPRIETARY AND CONFIDENTIAL**  
 THE INFORMATION CONTAINED IN THIS DRAWING IS THE SOLE PROPERTY OF SOUTH-TEK SYSTEMS. ANY REPRODUCTION IN PART OR AS A WHOLE WITHOUT THE WRITTEN PERMISSION OF SOUTH-TEK SYSTEMS IS PROHIBITED.

MATERIAL:						
FINISH:						
WEIGHT:			PROJECT NAME:			
			RELIABLE			
UNLESS OTHERWISE SPECIFIED DIMENSIONS ARE IN INCHES			NUMBER:			
ANGLES	X.	.X	.XX	.XXX	X/X<10'	X/X>10'
±.5°	±1	±.2	±.03	±.005	±1/16	±1/8

GENERAL ARRANGEMENT, SYSTEM FLOW AND CONNECTIONS				DRAWN:	APPROVED:
				PJS	SDA
GA-FPS-00900-RS				DATE:	DATE:
				11/29/18	11/29/18
REVISIONS: ONLY THE LATEST 3 REVISIONS WILL BE SHOWN. OLDER REVISIONS CONSOLIDATED AND FILED.				SCALE:	SHEET:
				1:12	5 OF 6
				REVISION:	
					03

8 7 6 5 4 3 2 1

GA-FPS-00900-RS, GENERAL ARRANGEMENT, SYSTEM FLOW AND CONNECTIONS, 03			
ITEM #	NUMBER	DESCRIPTION	QTY.
E5	105201	N2-BLAST LABEL FOR RELIABLE INTEGRATION CABINET	1

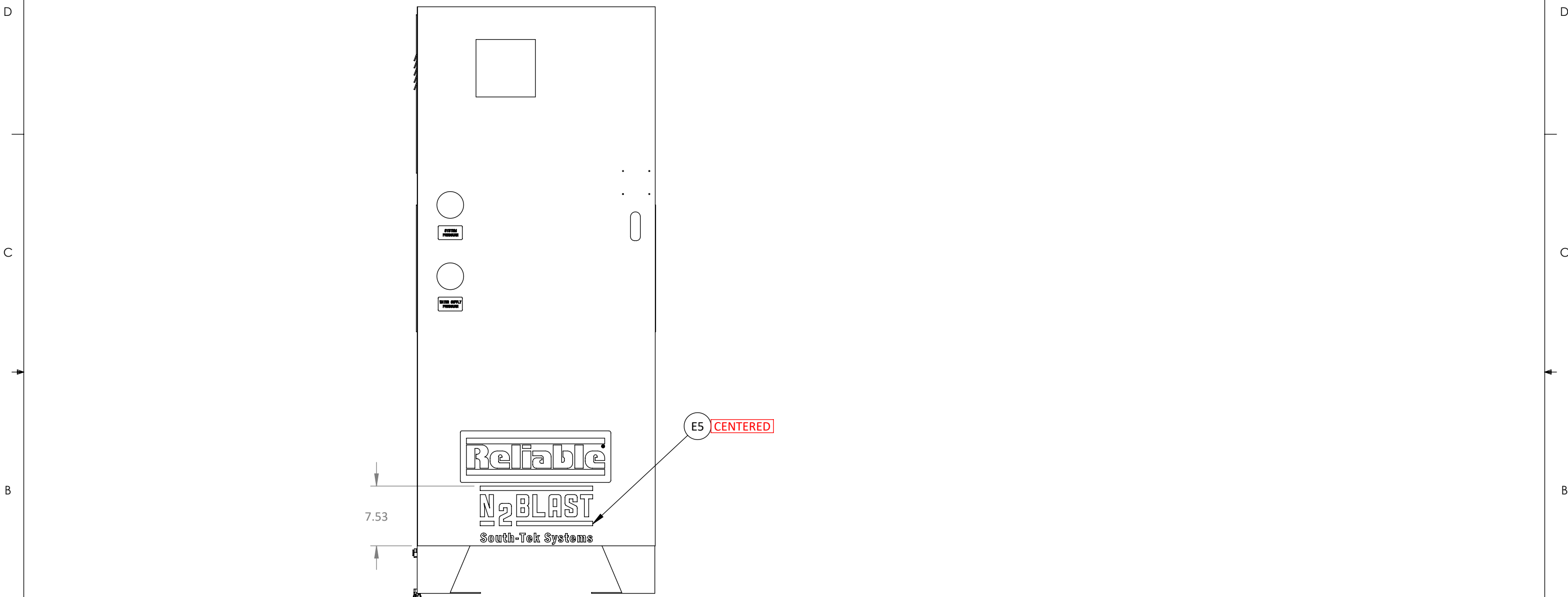

REV	TASK#	SHEET	DESCRIPTION	DATE	DRAWN	APPR.
03	10483	-	CLARIFYING WIRING DESCRIPTION	07/12/21	SRG	SDA
02	10481	-	WIRING HARNESS ADDED TO BOM, CHANGED 0.25"NPT X 0.375"PTC ELBOW TO 0.25"NPT X 0.25"PTC ELBOW	06/08/21	SRG	SDA
01	10404	-	UPDATED WITH NEW PLC	03/11/20	SRG	PJS

**REVISIONS: ONLY THE LATEST 3 REVISIONS WILL BE SHOWN. OLDER REVISIONS CONSOLIDATED AND FILED.**



**PROPRIETARY AND CONFIDENTIAL**  
THE INFORMATION CONTAINED IN THIS DRAWING IS THE SOLE PROPERTY OF SOUTH-TEK SYSTEMS. ANY REPRODUCTION IN PART OR AS A WHOLE WITHOUT THE WRITTEN PERMISSION OF SOUTH-TEK SYSTEMS IS PROHIBITED.

MATERIAL:						
FINISH:						
WEIGHT:			PROJECT NAME: RELIABLE			
UNLESS OTHERWISE SPECIFIED DIMENSIONS ARE IN INCHES						
ANGLES	X.	.X	.XX	.XXX	X/X<10'	X/X>10'
±.5°	±1	±.2	±.03	±.005	±1/16	±1/8

<b>GENERAL ARRANGEMENT, SYSTEM FLOW AND CONNECTIONS</b>			DRAWN: PJS	APPROVED: SDA
			DATE: 11/29/18	DATE: 11/29/18
SIZE: B		SCALE: 1:12	SHEET: 6 OF 6	
NUMBER: <b>GA-FPS-00900-RS</b>			REVISION: <b>03</b>	

8 7 6 5 4 3 2 1